

BLUE AIR BOX

STRAIGHT - DIRITTO



30°



90°



STRAIGHT - DIRITTO



30°



90°



CODE				FOR CARBURETORS:
	Ø	L	D	
203.0080	32	100	80	PHBG
203.0081	37	100	80	PHBG RACING
203.0082	46	100	80	CP POLINI

CODE				FOR CARBURETORS:
	Ø	L	D	
203.0090	32	115	80	PHBG
203.0091	37	115	80	PHBG RACING
203.0092	42	115	80	PHBH
203.0097	46	115	80	CP POLINI

CODE				FOR CARBURETORS:
	Ø	L	D	
203.0093	32	135	80	PHBG
203.0094	37	135	80	PHBG RACING
203.0095	32	125	65	PHBG
203.0096	37	125	65	PHBG RACING
203.0098	46	140	80	CP POLINI

CODE				FOR CARBURETORS:
	Ø	L	D	
203.0110	32	100	80	PHBG
203.0111	37	100	80	PHBG RACING
203.0112	46	100	80	CP POLINI

CODE				FOR CARBURETORS:
	Ø	L	D	
203.0113	32	115	80	PHBG
203.0114	37	115	80	PHBG RACING
203.0115	42	115	80	PHBH
203.0162	46	115	80	CP POLINI

CODE				FOR CARBURETORS:
	Ø	L	D	
203.0116	32	135	80	PHBG
203.0117	37	135	80	PHBG RACING
203.0163	46	140	80	CP POLINI

METAL AIR FILTERS | FILTRI ARIA IN METALLO

STRAIGHT - DIRITTO

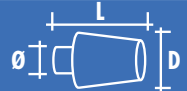

CODE				FOR CARBURETORS:
	Ø	L	D	
203.0060	35	81	74	PHVA-PHBN-PHBG-PHBD
203.0061	38	83	74	PHBL
203.0064	35	68	60	PHVA-PHBN-PHBG-PHBD
203.0065	38	70	61	PHBL

30°

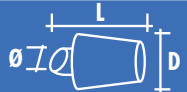

CODE				FOR CARBURETORS:
	Ø	L	D	
203.0062	35	110	75	PHVA-PHBN-PHBG-PHBD
203.0063	38	110	75	PHBL

90°



CODE				FOR CARBURETORS:
	Ø	L	D	
203.0066	34	105	61	PHVA-PHBN-PHBG-PHBD
203.0067	38	120	71	PHBL



APPLICATIONS TABLE

CYLINDER KITS

MUFFLERS

TRANSMISSIONS

FUEL SYSTEMS

ENGINE SPARE PARTS

SETUP

BLUE LINE

MINIBIKES

HI-SPEED E-BIKE

SPECIAL AIR BOX FILTERS

STRAIGHT - DIRITTO

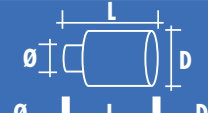

CODE				FOR CARBURETORS:
	Ø	L	D	
203.0036	32	63	80	PHBG-PHBD
203.0032	36	60	80	PHVA-PHBN
203.0040	39	63	80	PHBL-PHBH

STRAIGHT - DIRITTO

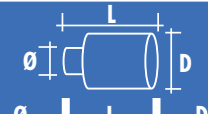

CODE				FOR CARBURETORS:
	Ø	L	D	
203.0034	32	95	80	PHBG-PHBD
203.0030	36	95	80	PHVA-PHBN
203.0038	39	95	80	PHBL-PHBH

30°

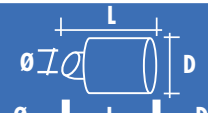

CODE				FOR CARBURETORS:
	Ø	L	D	
203.0048	32	92	80	PHBG-PHBD
203.0044	36	92	80	PHVA-PHBN
203.0052	39	92	80	PHBL-PHBH

30°

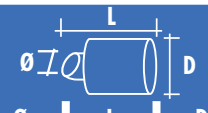

CODE				FOR CARBURETORS:
	Ø	L	D	
203.0046	32	118	80	PHBG-PHBD
203.0042	36	118	80	PHVA-PHBN
203.0050	39	105	80	PHBL-PHBH

90°

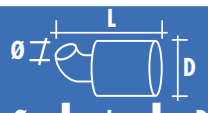

CODE				FOR CARBURETORS:
	Ø	L	D	
203.0055	34	100	80	PHVA-PHBN-PHBG-PHBD
203.0057	38	100	80	PHBL

90°

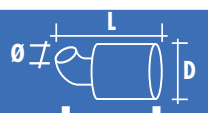

CODE				FOR CARBURETORS:
	Ø	L	D	
203.0054	34	130	80	PHVA-PHBN-PHBG-PHBD
203.0056	38	125	80	PHBL

SPECIAL AIR BOX FILTERS

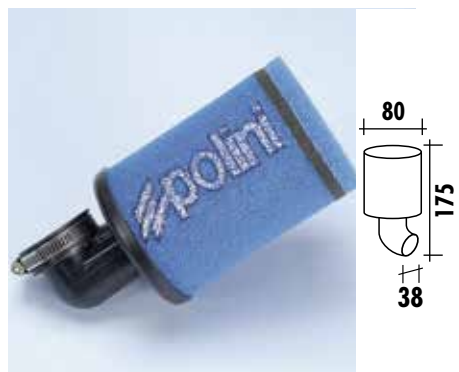

203.0029 | Ø38 - Scooters Evolution PHBG

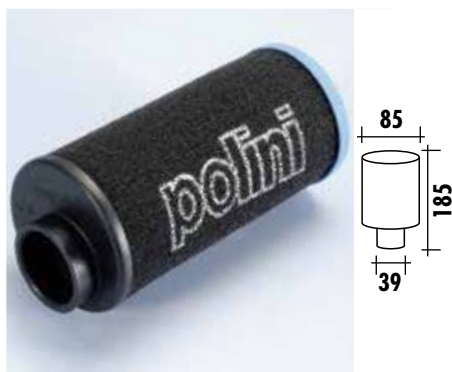

203.0146 | Ø39 - Scooters Evolution - PHBG



203.0147 | Scooters Big Evolution

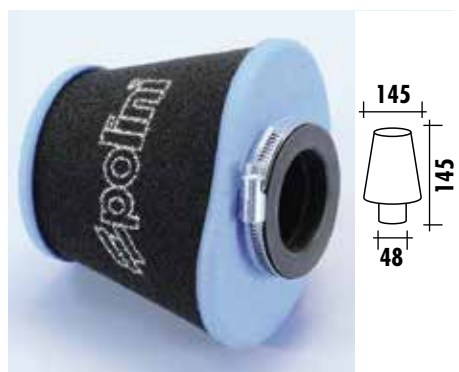

203.0150 | Ø48 Scooters Big Evolution - PWK

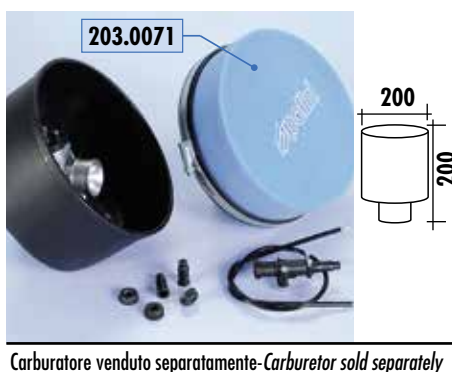

Carburatore venduto separatamente - Carburetor sold separately

203.0070 | Scooters Evolution

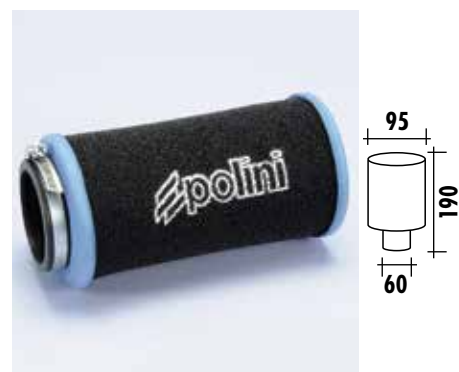

203.0164 | Ø60 - Scooters - Carburetor POLINI CP



203.0159 | Ø48 - Scooters Big Evolution - PWK



203.0160 | Scooters Big Evolution

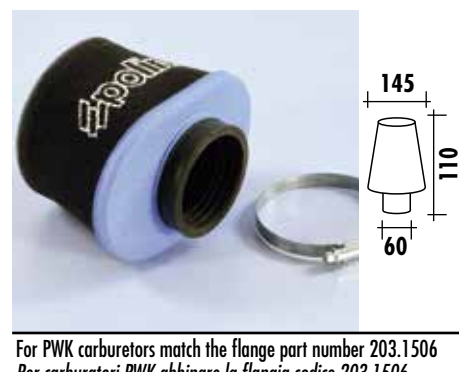

*For PWK carburetors match the flange part number 203.1506
 Per carburatori PWK abbinare la flangia codice 203.1506*

203.0166 | Ø60 CP Polini



203.0169 | Vespa PX 125/150



203.0170 | Air Filter Protec. sock - Calza Protec. filtro Aria

APPLICATIONS TABLE

CYLINDER KITS

MUFFLERS

TRANSMISSIONS

FUEL SYSTEMS

ENGINE SPARE PARTS

SETUP

BLUE LINE

MINIBIKES

HI-SPEED E-BIKE

VESPA-APE-CIAO AIR FILTERS | FILTRI ARIA VESPA-APE-CIAO



203.0014 VESPA 125 POLINI CP

203.0024 Ø24 VESPA 125 Dell'Orto



203.0015 VESPA 50/125 ET3-APE POLINI CP



203.0019 Ø19 VESPA 50-125 Dell'Orto



203.0016 Ø16 VESPA 50 Dell'Orto



203.0158

203.0152 Air filter original carb.24/24 Vespa P200E - filtro carb.originale

203.0153 Air filter original carb.20/20 Vespa PX125/150 - filtro carb.originale

PEUGEOT AIR FILTER FILTRO ARIA PEUGEOT



203.0013 Piaggio CIAO - SI



203.0011 Ø46 POLINI CP



928.465.014 PWK Ø 24/26/28/30

AIR INTAKE CONNECTORS | CORNETTI ASPIRAZIONE



203.1501 Ø44

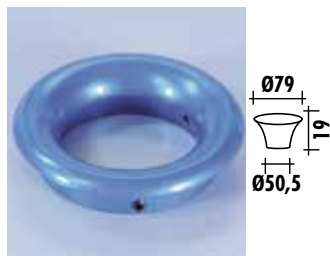

203.1502 Ø50,5



203.1503 Ø55,5

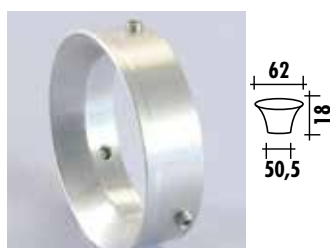

203.1504 M32x1,25 - PHBG

203.1505 Ø50,5 for Polini Racing
Carburetors Ø24-26-28-30

203.1506 PWK 24/26/28/30

AIR FILTER FOR SEVERAL APPLICATIONS | FILTRO ARIA PER DIVERSE APPLICAZIONI



CODE	A
928.465.001	Ø 16
928.465.002	Ø 18
928.465.003	Ø 22

CODE	A
928.465.004	Ø 16
928.465.005	Ø 17
928.465.006	Ø 18
928.465.007	Ø 19
928.465.009	Ø 22

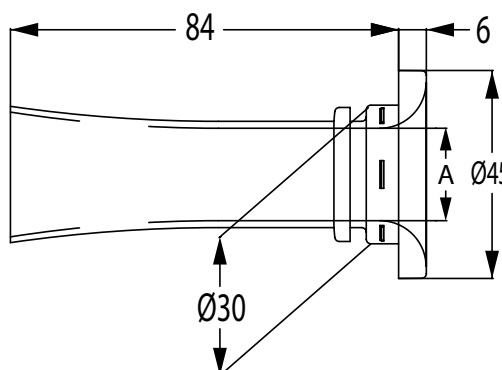
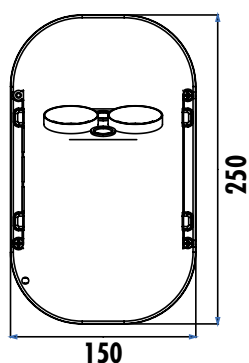
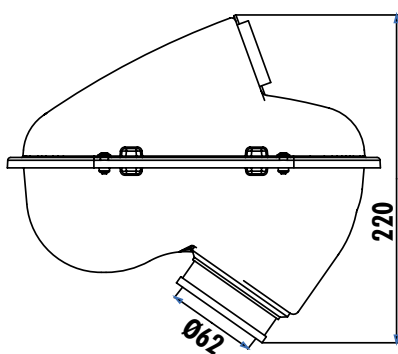

APPLICATIONS TABLE

CYLINDER KITS

MUFFLERS

TRANSMISSIONS

FUEL SYSTEMS

ENGINE SPARE PARTS

SETUP

BLUE LINE

MINIBIKES

HI-SPEED E-BIKE

ORIGINAL FILTERS | FILTRI ORIGINALI

Improve air flows during the intake phase. Thanks to their characteristic of filtering and purifying the air perfectly, they optimize the fuel-air mixture increasing the value so that the engine is more performing. They are made up of two sponge layers; a finer one of light blue color with 60 PPI porosity and one opener of black color with 30 pp porosity. The external surface is waved. It offers a greater entrance of the air flow, retaining a 50% more of dust particles.

Migliorano i flussi d'aria in fase d'aspirazione. Grazie alla loro caratteristica di filtrare e depurare perfettamente l'aria ottimizzano la miscela aria-benzina aumentando i valori così da rendere il motore decisamente performante. Sono composti da due strati di spugna; uno più fine di colore azzurro con porosità di 60 PPI ed uno più aperto di colore nero con porosità di 30 PPI. La superficie esterna si distingue per essere ondulata, offrendo una maggiore entrata dei flussi d'aria ma trattenendo nel tempo stesso il 50% in più della polvere grossolana.



				
203.0122	203.0123	203.0124	203.0125	203.0126
				
203.0128	203.0129	203.0130	203.0132	203.0133
				
203.0134	203.0135	203.0136	203.0137	203.0138
				
203.0139	203.0140	203.0141	203.0142	203.0143
				
203.0145	203.0151	203.0155	203.0156	203.0165
30x40 cm.		Yamaha Giggle	Honda SH 125-150	Piaggio Beverly-X10 350 ie LC
203.0157				
29x20 cm.				

da ritagliare/to recut

203.0167

203.0168
APPLICATIONS FOR ORIGINAL FILTERS | APPLICAZIONI PER FILTRI ORIGINALI

MODEL	CODE
APRILIA	
AREA 51 50 2t LC	203.0122
ATLANTIC - ARRECIFE 125 4t LC	203.0134
ATLANTIC-ARRECIFE 250 4t LC (Piaggio M237M)	203.0134
ATLANTIC-ARRECIFE 400 4t LC SPRINT (Piaggio M348M)	203.0134
ATLANTIC-ARRECIFE 500 4t LC SPRINT (Piaggio M273M)	203.0134
ATLANTIC 200 4t LC (PIAGGIO M234M)	203.0134
GULLIVER 50 2t	203.0122
MOJITO RY 125 (LEADER)	203.0151
RALLY 50 2t	203.0122
RALLY 50 2t LC	203.0122
SCARABEO 250 4t LC ie Light 2007 -->	203.0134
SCARABEO 400 - 400 ie Light 2007 --> 4t LC	203.0134
SCARABEO 50 2t STREET (PIAGGIO)	203.0128
SCARABEO 500 4t LC ie Light 2007 -->	203.0134
SONIC 50 2t LC	203.0122
SPORTCITY (PIAGGIO M281M) 125 4t LC	203.0134
SPORTCITY (PIAGGIO M288M) euro 3 - 200 4t LC	203.0134
SPORTCITY (PIAGGIO M288M) ie euro 3 50 4t LC	203.0134
SPORTCITY CUBE (LEADER M28LM) ie euro3-300 4t LC	203.0134
SR 50 2t 1994 -->	203.0122
SR 50 2t LC 2004-carb (PIAGGIO)	203.0123
SR 50 2t LC DITECH (APRILIA)	203.0123
SR 50 2t LC DITECH GP1 (PIAGGIO C361M)	203.0123
SR 50 2t LC NETSCAPER (MINARELLI)	203.0122
SR 50 2t LC R FACTORY (PIAGGIO C361M)	203.0124
SR 50 2t LC RACING (MINARELLI)	203.0122
SR 50 2t LC R-carb (PIAGGIO)	203.0124
SR 50 2t LC REPLICA	203.0122
SR 50 2t LC REPLICA 2000 (APRILIA)	203.0123
SR 50 2t LC STEALTH (MINARELLI)	203.0122
SR 50 2t MOTARD Euro 4 (CA41M)	203.0128
SR 50 2t WWW	203.0122
SR MAX 125 ie Euro 3	203.0134
SR MAX 300 ie	203.0134
BENELLI	
BENELLI VELVET 250 4t LC	203.0143
BSV	
BSV AX 50	203.0130
BSV GZ 50	203.0130
CPI	
ARAGON GP 50 2t	203.0125
HUSSAR (50 C) <-2002 - 50 2t	203.0122
HUSSAR 2003-> - 50 2t	203.0125
OLIVER (50 C) <-2002 - 50 2t	203.0122

MODEL	CODE
OLIVER 2003-> - 50 2t	203.0125
POPCORN (50 C) <-2002 - 50 2t	203.0122
POPCORN 2003-> - 50 2t	203.0125
DERBI	
ATLANTIS 50 2t BULLET	203.0128
BOULEVARD 125 LEADER	203.0151
BOULEVARD 150 LEADER	203.0151
GP1 125 4t LC euro 2-3	203.0134
GP1 50 2t LC	203.0128
GP1 50 2t LC OPEN	203.0128
RAMBLA (PIAGGIO M287M) euro 3 - 125 4t LC	203.0134
RAMBLA euro 3 - 250 4t LC	203.0134
DINLI	
HELIX 50 2t (06A53) DL603	203.0130
HELIX 90 2t (06B93) DL603	203.0130
T.REX 50 2t	203.0130
EXPLORER	
CRACKER 50 2t (GE 1E 400 MB) 2003 -->	203.0125
GARELLI	
TS R 50 (1E40QMB) euro 2 - 50 2t	203.0125
GILERA	
DNA 50 2t LC	203.0128
FUOCO 500 4t LC ie euro 3	203.0134
ICE 50 2t	203.0128
NEXUS 125 4t LC euro 3	203.0134
NEXUS 250 4t LC i.e. euro 3	203.0134
NEXUS 300 4t LC i.e. euro 3	203.0134
RUNNER 125 2t LC FX	203.0126
RUNNER 125 4t LC VX 2006 -->	203.0134
RUNNER 180 2t LC FXR	203.0126
RUNNER 200 4t LC VXR <- 2005	203.0134
RUNNER 200 4t LC VXR 2006 -->	203.0134
RUNNER 50 2t LC	203.0129
RUNNER 50 2t LC SP <- 2005	203.0129
RUNNER 50 2t LC SP-carb (C451M) 2006 -->	203.0128
STALKER 50 2t	203.0129
STORM 50 2t	203.0137
TYPHOON 50 2t	203.0137
HONDA	
SH 125/150	203.0156
HUPPER	
MONTECARLO 30 (1E40QMB) 50 2t	203.0125
ITALJET	
DRAGSTER 125 2t LC	203.0126
DRAGSTER 180 2t LC	203.0126

MODEL	CODE
JUPITER 250 4t LC	203.0143
KEEWAY	
F-ACT 50 2t	203.0125
GOCCIA (KW1E40QMB-4) 50 2t	203.0125
HURRICANE (KW1E40QMB) euro 2 50 2t	203.0125
MATRIX (KW1E40QMB-4) 50 2t	203.0125
PIXEL (KW1E40QMB) euro 2 50 2t	203.0125
RY8 (KW1E40QMB-4) 50 2t	203.0125
LAVERDA	
QUASAR 50 2t (AR 03)	203.0130
MALAGUTI	
CENTRO 50 2t	203.0130
CIAK 50 2t	203.0130
F10 50 2t	203.0130
F10 WAP (QJ*CMA03C*) euro 2 50 2t	203.0130
F12 PHANTOM 50 2t	203.0130
F12 PHANTOM 50 2t LC	203.0130
F12 PHANTOM 50 2t LC DIGIT KAT	203.0130
F12 PHANTOM 50 2t LC DIGIT KAT euro 2	203.0130
MADISON (YAMAHA) 250 4t LC	203.0143
MADISON 3 (PIAGGIO) 125 4t LC	203.0134
MADISON 3 (PIAGGIO) 250 4t LC	203.0134
PHANTOM F12 R (QJ*CMA02C*) euro 2 50 2t	203.0130
PHANTOM F12 R euro 2 50 2t LC	203.0130
PHANTOM MAX 200 4t LC (PIAGGIO)	203.0134
PHANTOM MAX 250 4t LC (PIAGGIO M361M)	203.0134
YESTERDAY 50 2t	203.0130
MBK	
BOOSTER-BOOSTER NG/NAKED/ROCKET 50 2t (A137E) E2	203.0132
BOOSTER 50 2t euro 0-1 veicoli prodotti dal 90 al 94	203.0132
BOOSTER 50 2t NG euro 0-1	203.0132
BOOSTER 50 2t ROCKET euro 0-1	203.0132
BOOSTER 50 2t SPIRIT euro 0-1 veicoli prodotti dal 96 al 98	203.0132
EVOLIS 50 2t per veicoli PRODOTTI 1994 - 1995 .	203.0130
FIZZ 50 2t	203.0130
FORTE 50 2t	203.0130
HOT CHAMP 50 2t	203.0130
MACH G 50 2t	203.0130
MACH G 50 2t LC	203.0130
NITRO 50 2t LC	203.0130
OVETTO 50 2t	203.0130
SKYLINER 250 4t LC	203.0143
SORRISO 50 2t <- 1995 veicoli prodotti 1995	203.0130
SORRISO 50 2t 1996 -->	203.0130
STUNT 50 2t euro 2	203.0132

APPLICATIONS TABLE

CYLINDER KITS

MUFFLERS

TRANSMISSIONS

FUEL SYSTEMS

ENGINE SPARE PARTS

SETUP

BLUE LINE

MINIBIKES

HI-SPEED E-BIKE

MODEL	CODE
PEUGEOT	
BUXY 50 2t	203.0133
ELYSEO 50 2t	203.0133
LOOXOR 50 2t	203.0133
LOOXOR 50 2t TSDI	203.0133
METAL-X 50 2t	203.0133
SPEEDAKE 50 2t	203.0133
SPEEDFIGHT 2 50 2t LC 2004 [X-FIGHT 2]	203.0133
SPEEDFIGHT 50 2t	203.0133
SPEEDFIGHT 50 2t LC	203.0133
SQUAB 50 2t	203.0133
TREKKER 50 2t	203.0133
VIVACITY 50 2t	203.0133
VIVACITY COMPACT (FB2FP) 50 2t	203.0133
X-FIGHT 50 2t	203.0133
X-FIGHT 50 2t LC	203.0133
ZENITH 50 2t	203.0133
PIAGGIO	
BEVERLY (M285M) euro 1-2 - 250 4t LC	203.0134
BEVERLY (M345M) i.e. euro 3 - 400 4t LC	203.0134
BEVERLY 125 4t LC	203.0134
BEVERLY 200 4t LC	203.0134
BEVERLY 300 ie TOURER	203.0134
BEVERLY 300 ie 2010/2017	203.0134
BEVERLY 350 4V ie EURO3	203.0165
BEVERLY 500 4t LC i.e. euro 2-3	203.0134
BEVERLY CRUISER i.e. euro 3 - 500 4t LC	203.0134
CARNABY (QUASAR) i.e. euro 3 - 300 4t LC	203.0134
CARNABY 125 4t LC (LEADER M28FM) euro 3	203.0134
CARNABY 200 4t LC (LEADER M601M) euro 3	203.0134
DIESIS 50 01>	203.0128
FLY50 2T 05/12	203.0128
FLY50 4T 05/11	203.0151
FLY125/150 EURO 3 4T 05/12	203.0151
LIBERTY - LIBERTY S (LEADER) euro 3 - 200 4t	203.0136
LIBERTY 125 4t	203.0139
LIBERTY 50 2t 97/05	203.0135
LIBERTY 50 2t 04/12	203.0151
LIBERTY 50 4t 00/03	203.0136
LIBERTY 50 4t Rst 04/12	203.0136
LIBERTY 125/150 4t LEADER 00/03	203.0136
LIBERTY 125 4t Rst 04/11	203.0136
LIBERTY 125 4t ie 2v 11/12	203.0136

MODEL	CODE
MP3 (MASTER M474M) i.e. euro 3 - 400 4t LC	203.0134
MP3 500	203.0134
NRG 50 2t EXTREME 99/00	203.0129
NRG 50 2t MC3 ARIA	203.0129
NRG 50 2t LC MC2 <-- 1997	203.0137
NRG 50 2t LC MC2 1998 -->	203.0129
NRG 50 2t LC MC3 DD	203.0128
NRG 50 2t LC veicoli PRODOTTI nel 1994 - 1996	203.0137
NRG 50 2t LC Power DD 01/04	203.0128
NRG 50 2t MC3 DT 05/12	203.0128
NRG 50 PUREJET 02/12	203.0129
NTT 50 2t LC veicoli PRODOTTI 1995 --> 1996 .	203.0137
SFERA 50 2t RESTYLING VESPA ET2 50 2t [carb.]	203.0139
SKIPPER 125 2t LX	203.0126
SKIPPER 125 4t '00/02	203.0168
SKIPPER 150 2t LXT	203.0168
TYPHOON 50 2t 2007 -->	203.0128
TYPHOON 125 4T 10/12	203.0151
X7 (LEADER) euro 3 - 125 4t LC	203.0134
X7 (QUASAR M622M) i.e. euro 3 - 250 4t LC	203.0134
X8125/150 EURO 2	203.0151
X8 400 4t LC (M521M) ie euro 3	203.0134
X9 250 4t LC Evolution (M237M)	203.0134
X10 500 4T 4V IE EURO 3	203.0134
XEvo 400 4t LC (M521M) ie euro 3	203.0134
ZIP 50 2t	203.0140
ZIP 50 2t 2000	203.0128
ZIP 50 2t FAST RIDER veicoli prodotti nel 93-94	203.0140
ZIP 50 2t FAST RIDER veicoli prodotti nel 96-97	203.0141
ZIP 50 2t LC SP <-- 2000	203.0141
ZIP 50 2t LC SP 2001 -->	203.0128
ZIP 50 4t 00/12	203.0140
ZIP100 4t 06/10	203.0140
SUZUKI	
BURGMAN 400 4t LC AN [BUSINESS]	203.0142
BURGMAN 400 4t LC AN inject. (K429)	203.0142
VESPA	
VESPA 50 ET2 2t 2000	203.0139
VESPA 50 ET4 4t '00/05	203.0168
VESPA 50 LX 4t 05/12	203.0151
VESPA 50 LX 2t	203.0139
VESPA 50 LX 2t 05/12	203.0128
VESPA 50 LXV 2t 06/09	203.0128

MODEL	CODE
VESPA 50 PRIMAVERA 2T	203.0128
VESPA 50 PRIMAVERA 4T 4 Valvole	203.0151
VESPA 50 S (C381M) euro 2 - 50 2t 07/12	203.0128
VESPA 50 S 4T 08/12	203.0151
VESPA 50 SPRINT 50 2T	203.0128
VESPA 50 SPRINT 4T 4 Valvole	203.0151
VESPA 125 ET4 4t veicoli prodotti nel 1996-1998	203.0139
VESPA 125 ET4 4t '99/02	203.0168
VESPA 125 Granturismo 4t LC L (LEADER)	203.0138
VESPA 125 S 3V 4T ie 2012	203.0167
VESPA 125/150 LX 3V 4T ie 2012	203.0167
VESPA 125/150 LX ie 09/12	203.0151
VESPA 125/150 LXV ie 10/12	203.0151
VESPA 125/150 PRIMAVERA 3V 4T ie 2014	203.0167
VESPA 125/150 PRIMAVERA iGET 3V 4T ie 2016	203.0167
VESPA 125/150 S SPECIAL EURO 3 07/10	203.0151
VESPA 125/150 SPRINT 3V 4T ie 2014	203.0167
VESPA 125/150 SPRINT iGET 3V 4T ie 2016	203.0167
VESPA 150 GTS SUPER 3V 4T ie 2014	203.0167
VESPA 200 Granturismo 4t LC L (M312M)	203.0138
VESPA 250 GTS 4t LC i.e.	203.0138
VESPA 300 GTS Super (QUASAR M454M) E3	203.0138
YAMAHA	
AEROX 50 2t LC euro 0-1	203.0130
AEROX 50 2t LC euro 2	203.0130
AXIS 50 2t	203.0130
BREEZE 50 2t	203.0130
BW'S - BW'S NG 50 2t (A137E) euro 2	203.0132
BW'S 50 2t euro 0-1	203.0132
BW'S 50 2t NG euro 0-1	203.0132
GIGGLE 50	203.0155
JOG 50 2t	203.0130
JOG 50 2t R	203.0130
JOG 50 2t Z	203.0130
MAJESTY 250 4t LC	203.0143
NEO'S 50 2t	203.0130
SPY 50 2t	203.0132
TMAX 500 2004 - 2007	203.0144
TMAX 500 2008	203.0148
VINO 50 2t	203.0130
ZEST 50 2t	203.0130
ZUMA 50 2t	203.0132